

Andor iDus 401 Series

Workhorse laboratory and OEM
CCD platform

Key Specifications

- ✓ Peak QE up to 95%
- ✓ TE cooling down to -100°C
- ✓ Ultravac™ technology
- ✓ 26 x 26 µm pixels
- ✓ Low NIR etaloning options
- ✓ USB 2.0 connection
- ✓ Fringe suppression technology

Key Applications

- ✓ Raman
- ✓ Fluorescence
- ✓ Luminescence
- ✓ Photoluminescence
- ✓ Absorption/Transmission/Reflection
- ✓ Micro-spectroscopy
- ✓ Non-linear spectroscopy (SFG/SHG)



Introducing iDus 401 Series

The USB 2.0-based iDus series is a compact, yet feature-rich platform suitable for demanding spectroscopy applications such as low-light UV/NIR Photoluminescence or Raman spectroscopy, as well as day-to-day routine laboratory operation and integration into industry-grade systems.



Features and Benefits

Feature	Benefit
Peak QE up to 95%	Visible-optimized 'BVF' & infrared-optimized 'BR-DD' model
Fringe suppression technology as standard	Fringing greatly eliminated (Deep-Depletion) or minimized (Back-Thinned 'BVF')
TE cooling down to -100°C	Critical for elimination of dark current detection limit - no inconvenience associated with LN ₂
Ultravac™•1	Critical for sustained vacuum integrity and to maintain unequalled cooling and QE performance, year after year
Single UV-grade fused silica window	Best UV-NIR throughput performance, specific AR coating and wedge options available
26 x 26 μm pixels	Optimized format for high dynamic range and resolution
Software-selectable pre-amplifier gain	Choice of best SNR performance or dynamic range at the touch of a button
USB 2.0 connection	Ideal for laptop operation Seamless operation alongside USB-based Kymera and Shamrock spectrographs
Solis software for Spectroscopy	Comprehensive, user-friendly interface for simultaneous detector & spectrograph control
Software Development Kit (SDK)	Ease of control integration into complex setups: Matlab, Labview, Visual Basic, C/C++ or Python
Integrated in EPICS	Platform is fully integrated into the EPICS control software

Applications Guide

	DU 401 BVF	DU 401 BR-DD
Absorption/Transmittance/Reflection	●	○
Fluorescence & Luminescence	●	○
NIR Spectroscopy		●
Raman Spectroscopy (244 – 488 nm)	●	
Raman Spectroscopy (514, 532, 633 nm)	●	
Raman Spectroscopy (785, 830 nm)		●

○ = Suitable ● = Optimum

Key Specifications^{•2}

Model number	DU401A	DU401A BR-DD
Sensor options	● BVF: Back Illuminated CCD, Vis-optimized and anti-fringing	● BR-DD: Back Illuminated CCD, Deep Depletion with anti-fringing Optimum sensor for Near IR applications
Active pixels ^{•3}	1024 x 127	
Pixel size	26 x 26 μm	
Image area	26.6 x 3.3 mm with 100% fill factor	
Minimum temperatures ^{•4} Air cooled Coolant recirculator Coolant chiller, coolant @ 10°C, 0.75l/min	-80°C -95°C -100°C	
Max spectra per second ^{•5}	88 (10 row crop mode), 81 (Full Vertical Bin)	
System window type	BVF sensor: UV-grade fused silica, 'Broadband VUV-NIR', unwedged BR-DD sensor: UV-grade fused silica, 'VIS-NIR enhanced', wedged (Various AR coatings & MgF ₂ options available)	
Blemish specifications	Grade 1 sensor from supplier. Camera blemishes as defined by Andor Grade A See technical article: CCD blemishes and non uniformities black pixels and hot pixels on a ccd sensor	

Advanced Specifications^{•2}

Dark current, e-/pixel/sec @ max cooling						
BVF	0.003			-		
BR-DD	-			0.013		
Register well depth	1,000,000 e ⁻					
Read noise (e-) ^{•6}	33 kHz	50 kHz	100 kHz	33 kHz	50 kHz	100 kHz
BVF: Typ (Max)	7 (8)	10 (12)	12 (15)	-	-	-
BR-DD: Typ (Max)	-	-	-	5 (6)	6 (8)	10 (15)
Sensitivity (e-/count)	33 kHz	50 kHz	100 kHz	33 kHz	50 kHz	100 kHz
High Dynamic Range mode	2.5	3.5	16	2.5	4.5	18.2
High Sensitivity mode	-	2.5	11	-	2.7	12
Linearity ^{•7}	Better than 99%					
Digitization	16 bit					
Vertical clock speed ^{•8}	8, 16, 32, 64 μs (software selectable)					

Dark Current •⁹

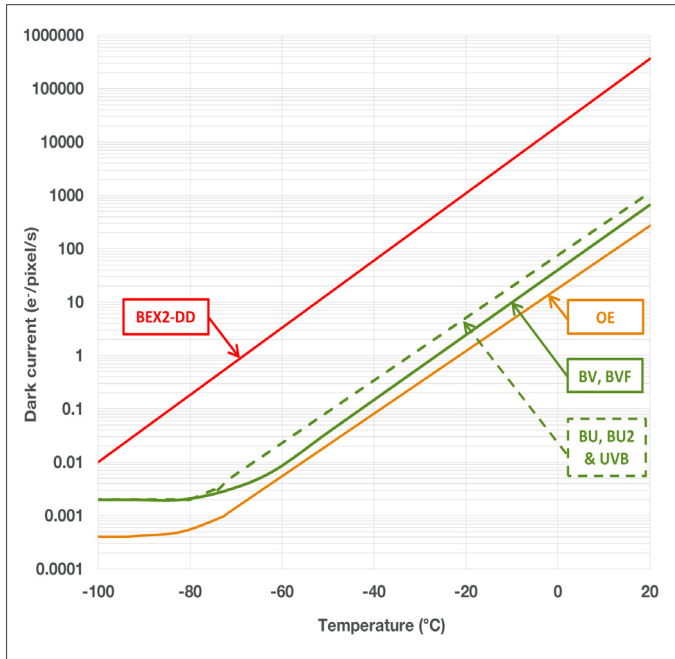

Quantum Efficiency Curves •¹⁰

25°C

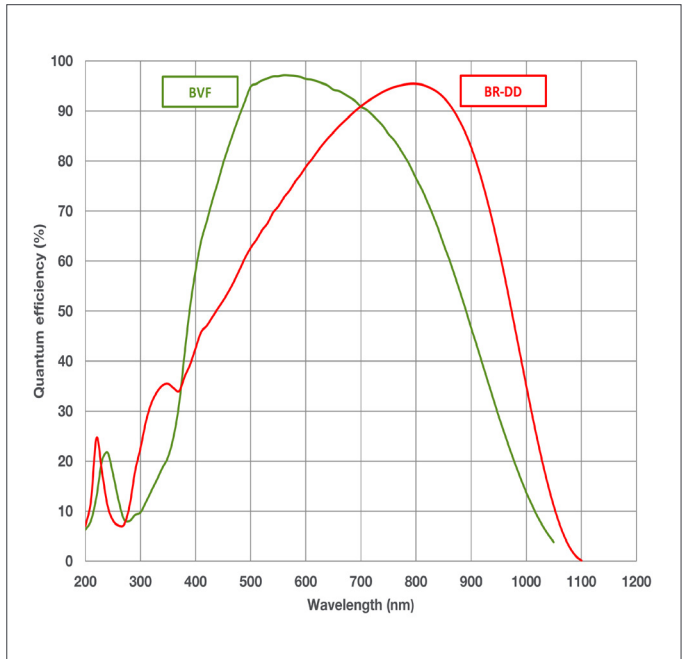

Typical Setup

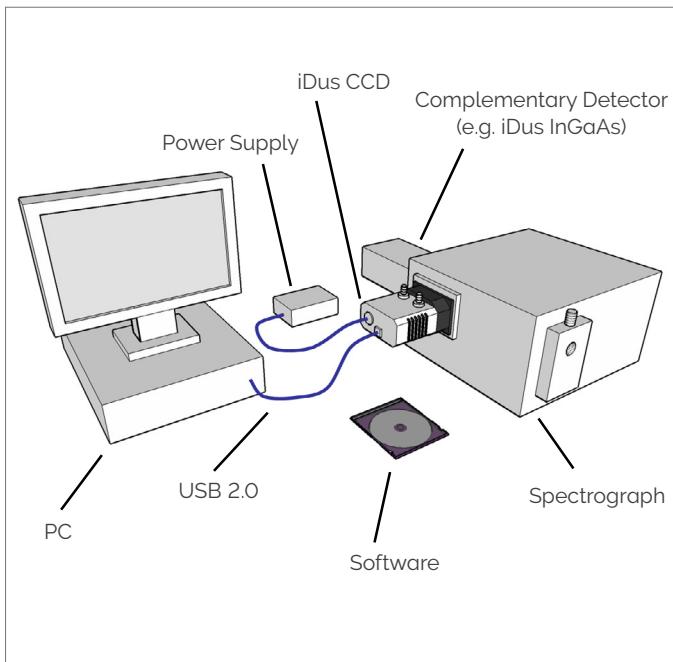

Quantum Efficiency Curves •¹⁰

-100°C

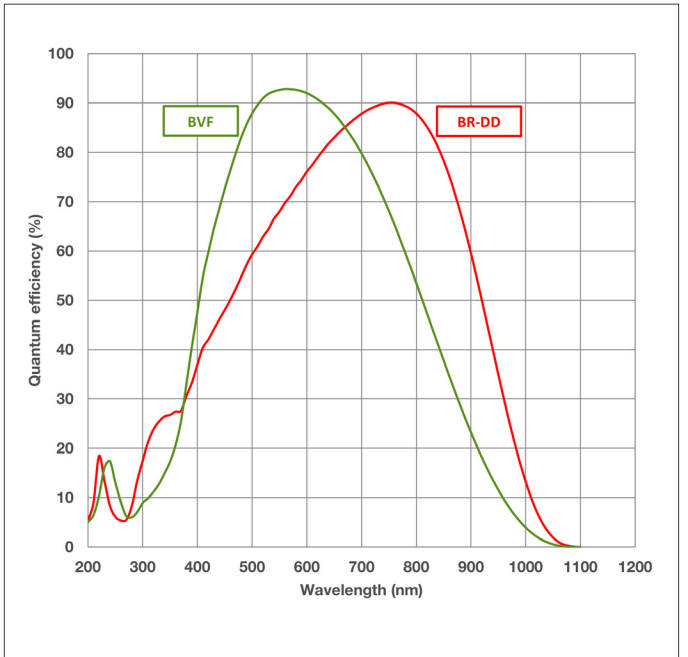

Creating the Optimum Product for you



DU-401A-**BVF**

example shown

Step 1. Cooling option



Cooling

Description	Code
Deep cooling: (Air cooled: -80°C, Coolant recirculator: -95°C, Coolant chiller, coolant @ 10°C, 0.75 l/min.: -100°C)	DU

Step 2. Choose the sensor type option



Sensor Type

Description	Code
Back-Illuminated CCD, Vis-optimized with anti-fringing	BVF
Back-Illuminated, Deep Depletion CCD with anti-fringing	BR-DD

Step 3. Select an alternative camera window (optional)



Camera Window

The standard window has been selected to satisfy most applications. However, other options are available. The alternative camera window code must be specified at time of ordering.

To view and select other window options please refer to the [Camera Windows Selector Tool](#). Further detailed information on windows can be found in the technical note - [How to Select a Window for your Camera](#).

Step 4. Select the required accessories and adapters

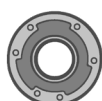

Accessories & Adapters

Description	Order Code
Coolant re-circulator for enhanced cooling performance	XW-RECR
Oasis 160 Ultra Compact Chiller Unit (tubing to be ordered separately)	ACC-XW-CHIL-160
6 mm tubing options for ACC-XW-CHIL-160 (2x2.5 m or 2x5 m lengths)	ACC-6MM-TUBING-2X2.5 / ACC-6MM-TUBING-2X5M
C-mount lens adaptor	ACC-LM-C
F-mount lens adaptor	ACC-LM-NIKON-F
Nikon F-mount lens adaptor with shutter	LMS-NIKON-F-NS25B
Shutter Driver for NS25B Bistable Shutter (<u>not</u> needed for Kymera/Shamrock spectrographs)	ACC-SD-VED24
Bistable Shutter, Standalone (<u>not</u> needed for Kymera/Shamrock spectrographs)	ACC-SHT-NS25B

Spectrograph Compatibility

The iDus series is fully compatible with Andor's Kymera and Shamrock spectrographs (193 - 750 mm focal lengths). Spectrograph mounting flanges and software control are available for a wide variety of third party spectrographs including McPherson (including 1 m and greater focal length option), JY/Horiba (excluding USB models), PI/Acton, Chromex/Bruker, Oriol/Newport, Photon Design, Dongwoo, Bentham, Solar TII and others.

Step 5. Select the required software



Software

The iDus requires at least one of the following software options:

Solis for Spectroscopy A 32-bit and fully 64-bit enabled application for Windows (8.1, 10 and 11) offering rich functionality for data acquisition and processing. AndorBasic provides macro language control of data acquisition, processing, display and export. Control of Andor Kymera and Shamrock spectrographs and a very wide range of third party spectrographs is also available, see list in step 4 above.

Andor SDK A software development kit that allows you to control the Andor range of cameras from your own application. Available as 32/ 64-bit libraries for Windows (8.1, 10 and 11) and Linux. Compatible with C/C++, C#, Delphi, VB.NET, LabVIEW, MATLAB and Python.

Product Drawings

Dimensions in mm (inches)

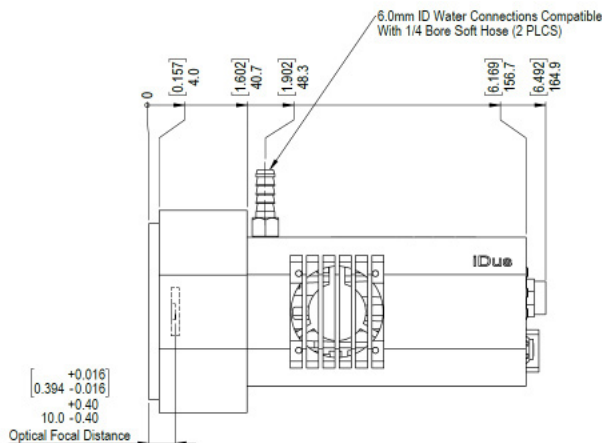
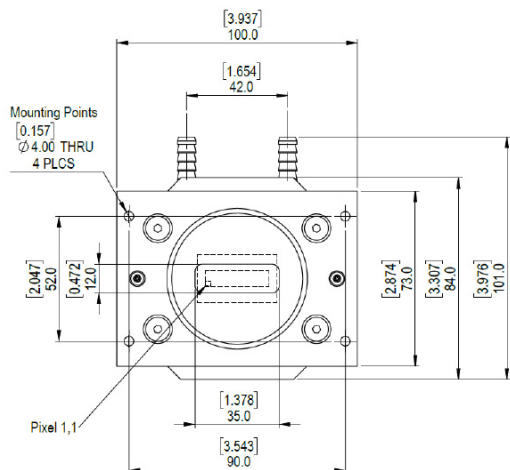

Mounting hole locations

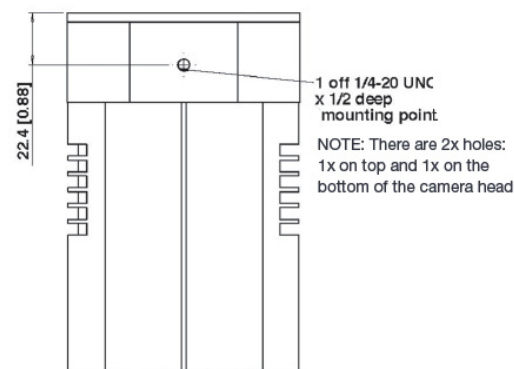
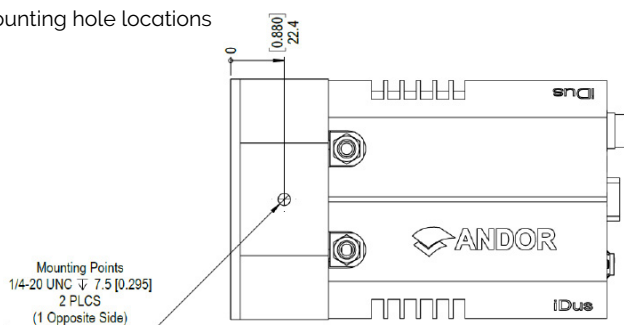

Connecting to the iDus

Camera Control

Connector type: USB 2.0

TTL / Logic

Connector type: SMB, provided with SMB - BNC cable

1 = Fire (Output), 2 = External Trigger (Input), 3 = Shutter (Output)

I²C connector

Compatible with Fischer SC102A054-130

1 = Shutter (TTL), 2 = I²C Clock, 3 = I²C Data, 4 = +5 V_{DC}

5 = Ground)

Minimum cable clearance required at rear of camera 90 mm

Rear connector panel

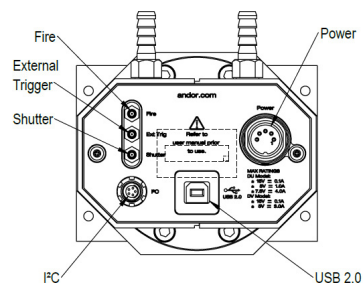

Weight 2 kg (4 lb 8 oz)

Have you found what you are looking for?

Need a larger sensor? The [iDus 420](#) series is similar to the 401 series with 26.6 x 6.6 mm format and 1024 x 255 pixels.

Need to work further into the NIR? The [iDus InGaAs](#) series, with up to 1024 pixel linear array with transmission to 2.2 μm.

Need a faster or more sensitive CCD? The [Newton series](#) offers over 1,600 spectra per second and EM technology.

Need more UV sensitivity? The [iDus 420](#) series is similar to the 401 series with a range of UV optimized sensors.

Need a customized version? Please contact us to discuss our Customer Special Request options.

The iDus series combines seamlessly with Andor's research grade Kymera and Shamrock Czerny-Turner spectrographs.



Our Cameras for Spectroscopy

Spectroscopy-based diagnostics in the fields of Material Science, Chemistry, Life Science or Fundamental Physics & Optics rely on the capture and analysis of optical and chemical signatures with a high degree of precision.

Andor's range of detectors offer a wide range of sensitivity, time-resolution and sensor formats to best suit specific experimental conditions from UV to SWIR, nanosecond to hours time resolution, high photon flux to single photon with super dynamic range and resolution.

High Sensitivity & Dynamic Range



- ✓ Long exposure
- ✓ High sensitivity UV-SWIR
- ✓ Large pixel well depths
- ✓ High resolution matrix

iDus CCD & InGaAs | Newton CCD & EM

ns to μ s Time-Resolution



- ✓ Nanosecond gating
- ✓ High sensitivity down to single photon
- ✓ On-head DDG with ps accuracy

iStar CCD & sCMOS

kHz Spectral Rates

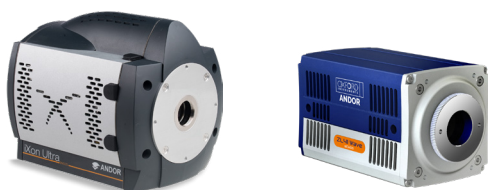

- ✓ μ s to ms time-resolution
- ✓ High sensitivity down to single photon
- ✓ High resolution matrix

Newton CCD & EMCCD | iXon EMCCD |
ZL41 Wave | Marana sCMOS

Extended Multi-fibre Spectroscopy

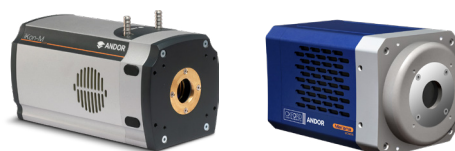

- ✓ Large area sensors
- ✓ Ultrafast sCMOS and EMCCD options
- ✓ High sensitivity down to single photon

iKon-M CCD | iXon EMCCD | Zyla sCMOS |
Marana sCMOS | iStar CCD & sCMOS

Learn more about our detector range [here](#).



Learn more about our spectrograph solutions [here](#).

Order Today

Need more information? At Andor we are committed to finding the correct solution for you. With a dedicated team of technical advisors, we are able to offer you one-to-one guidance and technical support on all Andor products.

For a full listing of our local sales offices, please see: andor.oxinst.com/contact

Our regional headquarters are:

Europe

Belfast, Northern Ireland
Phone +44 (28) 9023 7126
Fax +44 (28) 9031 0792

Japan

Tokyo
Phone +81 (3) 6744 4703
Fax +81 (3) 3446 8320

North America

Concord, MA, USA
Phone +1 (860) 290 9211
Fax +1 (860) 290 9566

China

Beijing | Shanghai | Guangzhou
Phone +86 (400) 678 0609
Fax +86 (10) 5884 7901



Footnotes: Specifications are subject to change without notice

- Assembled in a state-of-the-art facility. Andor's UltraVac™ vacuum process combines a permanent hermetic vacuum seal (no o-rings), with a stringent protocol and proprietary materials to minimize outgassing. Outgassing is the release of trapped gases that would otherwise degrade cooling performance and potentially cause sensor failure.
- Figures are typical unless otherwise stated.
- Edge pixels may exhibit a partial response.
- Minimum temperatures listed are typical values with ambient temperature of 25°C.
- Based on a Horizontal Pixel Readout of 100 kHz and a vertical pixel shift of 8 μs.
- System Readout Noise is for the entire system. It is a combination of CCD readout noise and A/D noise. Measurement is for Single Pixel readout with the CCD at a temperature of -50°C (BR-DD models tested at -80°C) and minimum exposure time under dark conditions. Noise is measured at the highest available pre-amplifier gain for each speed.
- Linearity is measured from a plot of counts vs exposure time under constant photon flux up to the saturation point of the system.
- Vertical speeds are software selectable. All sensors are designed to give optimum Charge Transfer Efficiency (CTE) at 16 μs vertical pixel shift, some decrease in CTE may be observed at faster shift speeds.
- The graph shows typical dark current level as a function of temperature. The dark current measurement is averaged over the CCD area excluding any regions of blemishes.
- Quantum efficiency of the sensor as supplied by the sensor manufacturer.

Items shipped with your camera

- 1x 2m BNC - SMB connection cable
- 1x 3m USB 2.0 cable Type A to Type B
- 1x Set of hex keys (7/64" & 3/32")
- 1x Power supply with mains cable
- 1x Electronic copy of user guides
- 1x Individual system performance booklet
- 1x Electronic copy of Solis software or SDK (if ordered)

Regulatory Compliance

Compliant with the requirements of the EU EMC and LVD Directives, compliant with the international EMC and safety standards IEC 61326-1 and IEC 61010-1.

Minimum Computer Requirements:

- 3.0 GHz single core or 2.4 GHz multi core processor
- 2 GB RAM
- 100 MB free hard disc to install software (at least 1 GB recommended for data spooling)
- USB 2.0 High Speed Host Controller capable of sustained rate of 40 MB/s
- Windows (8.1, 10 and 11)

Operating and Storage Conditions

- Operating Temperature: 0°C to 30°C ambient
- Relative Humidity: < 70% (non-condensing)
- Storage Temperature: -25°C to 50°C

Power Requirements

- 100 - 240 VAC, 50 - 60 Hz
- Power consumption: 42 W (max)



Windows is a registered trademark of Microsoft Corporation.
Labview is a registered trademark of National Instruments.
Matlab is a registered trademark of The MathWorks Inc.