

Andor ZL41 Cell sCMOS

Easy & Cost-Effective
Super-Resolution to ~ 100 nm

Key Specifications

- ✓ Sharp: ~100 nm resolution
- ✓ Fast: up to 100 fps
- ✓ Sensitive: up to 82% QE
- ✓ Accurate: >99.8% linearity
- ✓ Flexible: 4.2 and 5.5 Megapixels
- ✓ Productive: up to 22 mm field of view

Key Applications

- ✓ Live cell imaging
- ✓ Neuroimaging
- ✓ Developmental biology
- ✓ Cell and tissue imaging
- ✓ Calcium imaging
- ✓ Cell trafficking



Want Easy Super-Resolution?



You got it...

ZL41 Cell is compatible with our camera-based real-time super-resolution technology, SRRF-Stream+.

ZL41 Cell builds on the strengths of the original Zyla series: high-speed, high-sensitivity and high-resolution imaging performance. ZL41 Cell is perfectly suited to many experiments that push the boundaries of speed and sensitivity.

ZL41 Cell 4.2

ZL41 Cell 4.2 provides exceptional sensitivity for live cell imaging with a combination of 82% QE and very low 0.9 e⁻ read noise. An effective camera solution for almost any application from routine widefield fluorescence to demanding super-resolution and precise quantitative measurements alike.

- ✓ 4.2 Megapixel sensor format
- ✓ 82% QE and 0.9 e⁻ read noise
- ✓ Optimised mode for line scanning applications (LightScan PLUS)
- ✓ Camera-based super-resolution technology to ~ 100 nm (SRRF-Stream+)

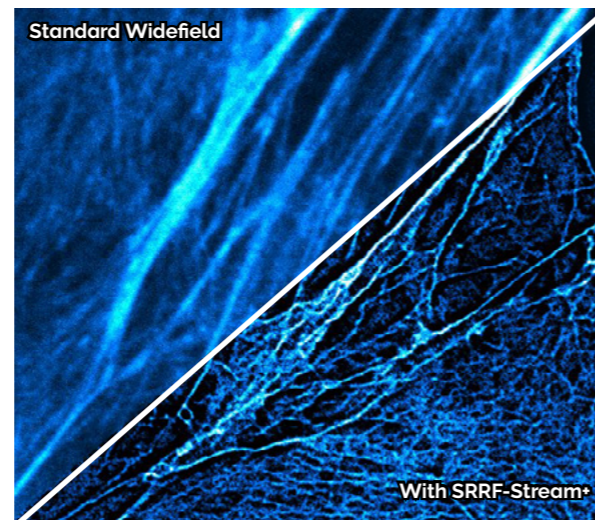

SRRF-Stream image of alpha-tubulin (red) and cell nuclei (cyan). Image credit Motosuke Tsutsumi National Institute for Physiological Science, Japan.

ZL41 Cell 5.5

Upgrade your existing CMOS or CCD camera and take your microscope to the next level! ZL41 Cell 5.5 is our most affordable sCMOS, packed with features. Uniquely equipped with [Global Shutter mode](#) for snapshot imaging of fast objects, free of motion artefacts.

- ✓ Larger 5.5 Megapixel sensor format
- ✓ 64% QE and 0.9 e⁻ read noise
- ✓ True global shutter and rolling shutter modes
- ✓ Our most affordable performance sCMOS

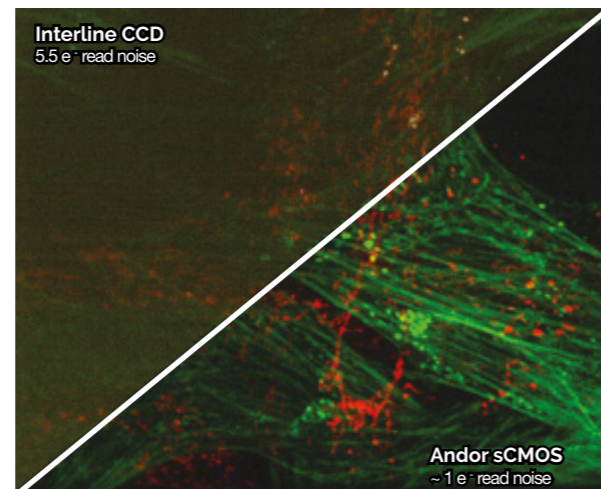

ZL41 Cell 5.5 is a perfect upgrade from standard CCD and CMOS cameras, offering lower noise, faster speeds and higher resolution.

ZL41 Cell Features Specifically for Life Sciences

NEW SRRF-Stream+	The most cost-effective and easy way to add super-resolution down to 100 nm to your existing microscope (ZL41 Cell only). Find out more on page 6 .
LightScan PLUS	Optimise signal strength and confocality in applications such as Scanned Light Sheet Microscopy and Line Scanning Confocal Microscopy with LightScan+.
FCS mode	Obtain the fastest possible speeds from minimal height ROIs configured for Fluorescence Correlation Spectroscopy experiments. ZL41 Cell 4.2 outputs a sustained 26,041 fps (2048 (w) x 8 (h) ROI) with exceptional temporal resolution.
GPU Express	Simplify and optimize data transfer from the camera – ideal for today's data intensive imaging experiments. Leverage CUDA-enabled NVidia GPU processing to accelerate the data acquisition pipeline with GPU Express.

Feature	Benefit
NEW Enhanced image quality	Updated QC processes ensure every ZL41 Cell delivers optimal image quality. Ultra-low PRNU for clear noise free images whatever the image conditions.
NEW Sensor chamber	An updated sensor chamber provides even greater long-term protection from condensation in high humidity environments (3 year chamber warranty).
NEW Python ready	Python wrapper integration and full supporting documentation in latest camera SDK helps integration and full control of custom-build systems.
QE_{max} boosted to 82%	High efficiency across visible/NIR, optimized for all common fluorophores. Shorter exposures, reduced phototoxicity, lower dye concentrations.
~ 1 e⁻ read noise	Noise floor down to 0.9 e ⁻ . Lower detection limit than any CCD.
Market leading USB 3.0 speed	ZL41 Cell delivers up to 53 fps full resolution. Follow dynamic processes with improved temporal resolution.
100 fps (Camera Link)	ZL41 Cell offers Camera Link for maximum sustained frame rates.
Global shutter option	Global shutter (ZL41 Cell 5.5) for 'interline CCD mode' freeze frame capture of fast moving/changing events.
Extended dynamic range	Unique 'dual gain amplifier' sensor architecture offering dynamic range of 33,000:1.
12-bit and 16-bit modes	12-bit mode for smaller file size and absolute fastest frame rates through USB 3.0; 16-bit mode for full dynamic range.
Better than 99.8% linearity	Unparalleled quantitative measurement accuracy across the full dynamic range.

Application and Techniques

Quality, Throughput, Performance, Accessibility...

- ✓ **High sensitivity & wide dynamic range** – quantify very weak and very bright structures with one image.
- ✓ **Superb image quality** – high resolution and uniform backgrounds for publication quality imaging.
- ✓ **Capture everything** – large field of view matches that of modern microscopes. Achieve better statistics and higher throughput in high content experiments.
- ✓ **Blazingly fast** – more and more studies of cell processes require greater temporal resolution. ZL41 Cell is fast and importantly keeps noise low.
- ✓ **Ease of use** – start imaging immediately with helpful documentation and features like Python integration in camera SDK.

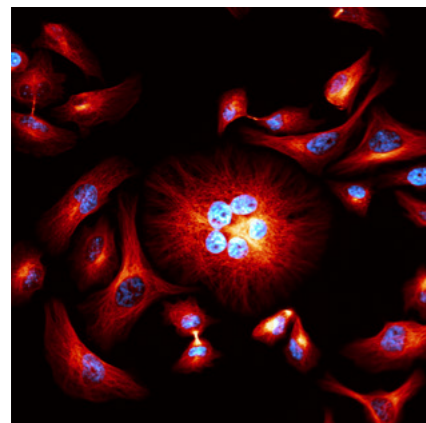

SRRF-Stream image of alpha-tubulin (red) and cell nuclei (cyan). *Image credit Motosuke Tsutsumi National Institute for Physiological Science, Japan.*

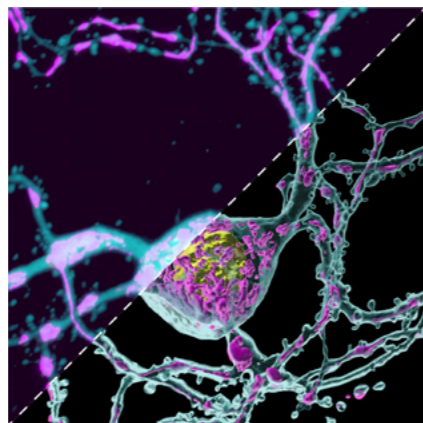

Neuron image taken using Andor sCMOS, Dragonfly, analysed with Imaris 9.5. *Image courtesy of Aubrianna Decker (Gaublomme Lab) and Daniel Virga (Polleux Lab).*

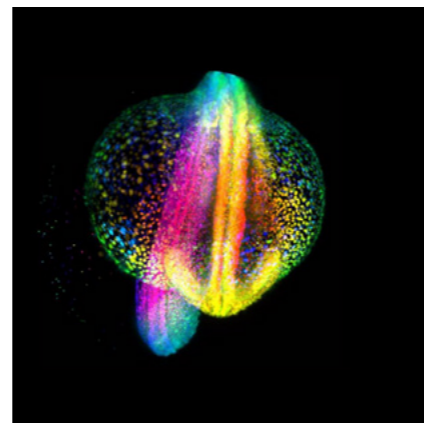

Light-sheet fluorescence microscopy image of Zebrafish embryo. *Image credit Gopi Shah, Max Planck Institute of Molecular Cell Biology and Genetics.*

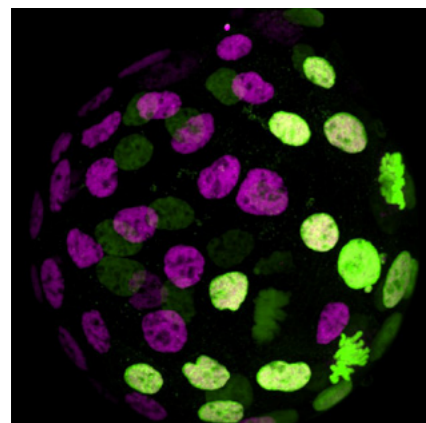

Single blastomeres of 2C embryos were injected with H2B-GFP mRNA and cultured to the blastocyst stage E4.5. *Image credit Martin Kinisu - UC Berkeley.*

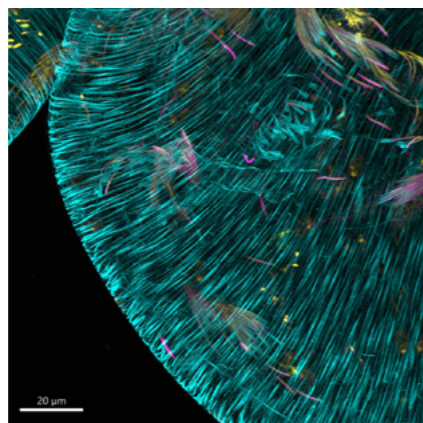

Drosophila testes showing different stages of sperm individualization (fixed tissue, IHC). Yellow: DAPI, Purple: protamine-GFP, Blue: phalloidin (actin).

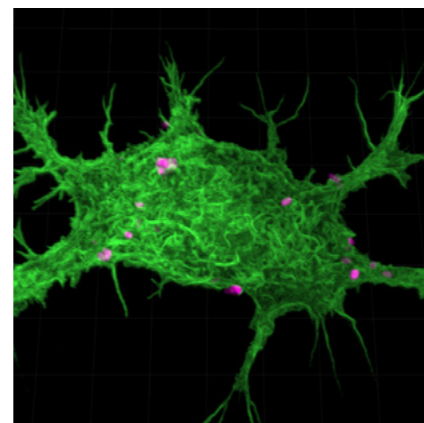

Murine Macrophage stained with AlexaFluor488 Phalloidin phagocytosing *E.coli* bioparticles labelled Alexa fluor 594. Captured at 100x magnification.

A camera for any application or technique

Application Requirement	sCMOS				EMCCD		CCD
	ZL41 Cell 5.5	ZL41 Cell 4.2	Sona-6	Sona-11	iXon 897 Life/Ultra	iXon 888 Life/Ultra	iKon-M
Capture weakest signals	■ ■ ■ ■ □ □	■ ■ ■ ■ □	■ ■ ■ ■ □	■ ■ ■ ■ □	■ ■ ■ ■ ■	■ ■ ■ ■ ■	■ □ □ □ □
High sensor resolution	■ ■ ■ ■ □	■ ■ ■ ■ □	■ ■ ■ ■ □	■ ■ ■ □ □	■ □ □ □ □	■ ■ □ □ □	■ □ □ □ □
Image a wide field of view	■ ■ ■ ■ ■	■ ■ ■ ■ □	■ ■ ■ ■ □	■ ■ ■ ■ ■	■ ■ □ □ □	■ ■ □ □ □	■ □ □ □ □
High speed imaging	■ ■ ■ ■ □	■ ■ ■ ■ □	■ ■ ■ ■ ■	■ ■ ■ □ □	■ ■ □ □ □	■ ■ □ □ □	■ □ □ □ □
High dynamic range	■ ■ ■ ■ □	■ ■ ■ ■ □	■ ■ ■ ■ □	■ ■ ■ ■ ■	■ ■ □ □ □	■ ■ □ □ □	■ ■ □ □ □
Long exposure suitability	■ □ □ □ □	■ □ □ □ □	■ □ □ □ □	■ □ □ □ □	■ ■ ■ ■ ■	■ ■ ■ ■ ■	■ ■ ■ ■ ■
Quantitative measurements	■ ■ ■ ■ ■	■ ■ ■ ■ ■	■ ■ ■ ■ ■	■ ■ ■ ■ ■	■ ■ ■ ■ ■	■ ■ ■ ■ ■	■ ■ ■ ■ ■

■ □ □ □ □ - Not suitable ■ ■ ■ ■ ■ - Optimal

Super-Resolution Ready

SRRF-STREAM+

Want to enable fast and easy super-resolution down to 100 nm? Our exclusive camera-based technology enables super-resolution microscopy on conventional modern fluorescence microscopes in real-time.

SRRF (Super-Resolution Radial Fluctuations), is a highly effective approach to super-resolution developed by the Henriques research group (Gustafsson et al., 2016). Andor's unique and exclusive implementation of SRRF-Stream+ allows camera-based real-time super-resolution with low illumination intensities and normal fluorescent labels.



- ✓ **Capture vibrant images** – with stunning detail and high contrast.
- ✓ **Conventional fluorophores** – simple labelling, no photo-switching required.
- ✓ **Cost-effective** – convert conventional fluorescence microscopes to super-resolution microscopes.
- ✓ **Real time** – enhanced workflow, avoids post-processing. View in 'Live Mode'.
- ✓ **Low excitation intensities** – prolonged live cell observations & accurate physiology.

Read our [SRRF-Stream+ technical note](#) to find out more on how you can convert your microscope to super-resolution capabilities.

STORM, PALM & DNA PAINT

The high sensitivity, low noise and high-speed capabilities of ZL41 Cell are well suited to single molecule based 'STORM / PALM' and DNA PAINT approaches, revealing biological information down to ~10 nm.

Right: Revealing the cytoskeleton of the cell in highly-resolved vibrant detail with Andor sCMOS and SRRF-Stream. *Image credit Motosuke Tsutsumi - National Institute of Physiological Science.*

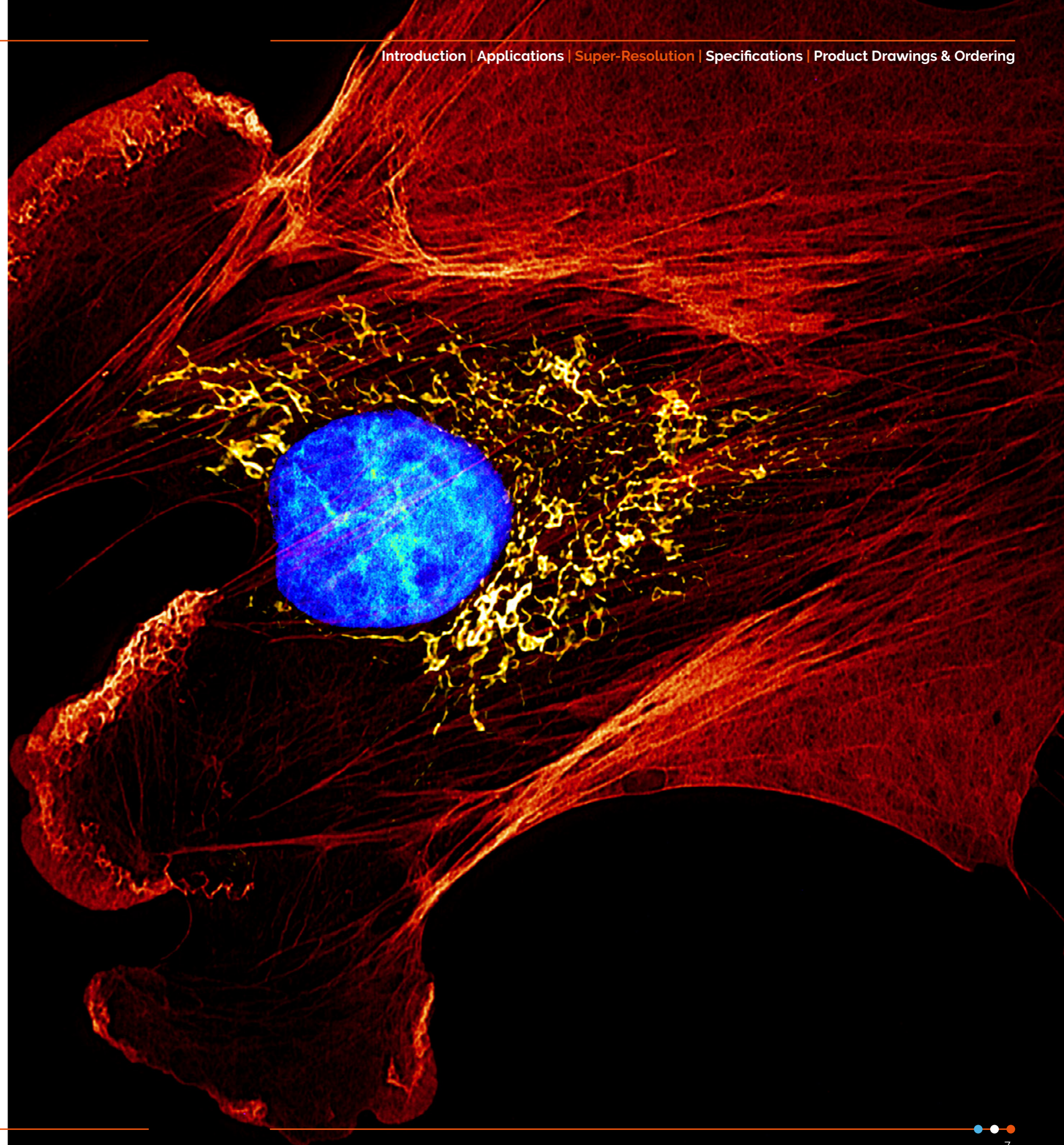

Technical Specifications

Model Specific Specifications^{*1}

Model	ZL41 Cell 5.5	ZL41 Cell 4.2
Sensor type	Front Illuminated Scientific CMOS	Front Illuminated Scientific CMOS
Active pixels (W x H)	2560 x 2160 (5.5 Megapixel)	2048 x 2048 (4.2 Megapixel)
Sensor size	16.6 x 14.0 mm 21.8 mm diagonal	13.3 x 13.3 mm 18.8 mm diagonal
Pixel readout rate (MHz)	200 (100 MHz x 2 sensor halves) 560 (280 MHz x 2 sensor halves)	216 (108 MHz x 2 sensor halves) 540 (270 MHz x 2 sensor halves)
Read noise (e ⁻) Median [rms] ^{*2}	Rolling Shutter @ 200 MHz 0.9 [1.2] @ 560 MHz 1.2 [1.6]	Global Shutter 2.3 [2.5] 2.4 [2.6]
Maximum Quantum Efficiency ^{*3}	64%	82%
Sensor Operating Temperature	0°C (up to 30°C ambient)	0°C (up to 27°C ambient)
Air cooled		
Water cooled	-10°C*	-10°C*
Dark current, e ⁻ /pixel/sec @ min temp ^{*4}	0.10	0.10
Air cooled		
Water cooled	0.019	0.019
Readout modes	Rolling Shutter and True Global Shutter (Snapshot)	Rolling Shutter and Global Clear ^{*7}
Maximum dynamic range	33,000:1	33,000:1
Photon Response Non-Uniformity (PRNU)		
Half-light range		< 0.01%
Low light range		< 0.1%
User defined ROI (granularity)		Yes (1 pixel) ^{**}
Data range		12-bit (fastest USB 3.0 speeds) and 16-bit (maximum dynamic range)
Interface options		USB 3.0 ^{*8} or Camera Link
SRRF-Stream+ Compatible	No	Yes

* Cooling temperature must be above the dew point

** Minimum ROI size: 4 x 8 (W x H) possible for 12- or 16-bit modes and for both Camera Link and USB 3.0 models

General Specifications^{*1}

Pixel size (W x H)	6.5 μm
Pixel well depth (e ⁻)	30,000
Linearity (% maximum) ^{*5}	Better than 99.8%
Full light range	Better than 99.9%
Low light range (< 1000 electrons signal)	
MTF (Nyquist @ 555 nm)	45%
Pixel binning	Hardware binning: 2 x 2, 3 x 3, 4 x 4, 8 x 8
Anti-blooming factor	x 10,000
I/O	External Trigger, Fire, Fire n, Fire All, Fire Any, Arm
Trigger Modes	Internal, External, External Start, External Exposure, Software Trigger
Software Exposure Events ^{*6}	Start exposure - End exposure (row 1), Start exposure - End exposure (row n)
Hardware timestamp accuracy	25 ns
Internal memory	1 GB

Quantum Efficiency (QE) Curve ^{*3}

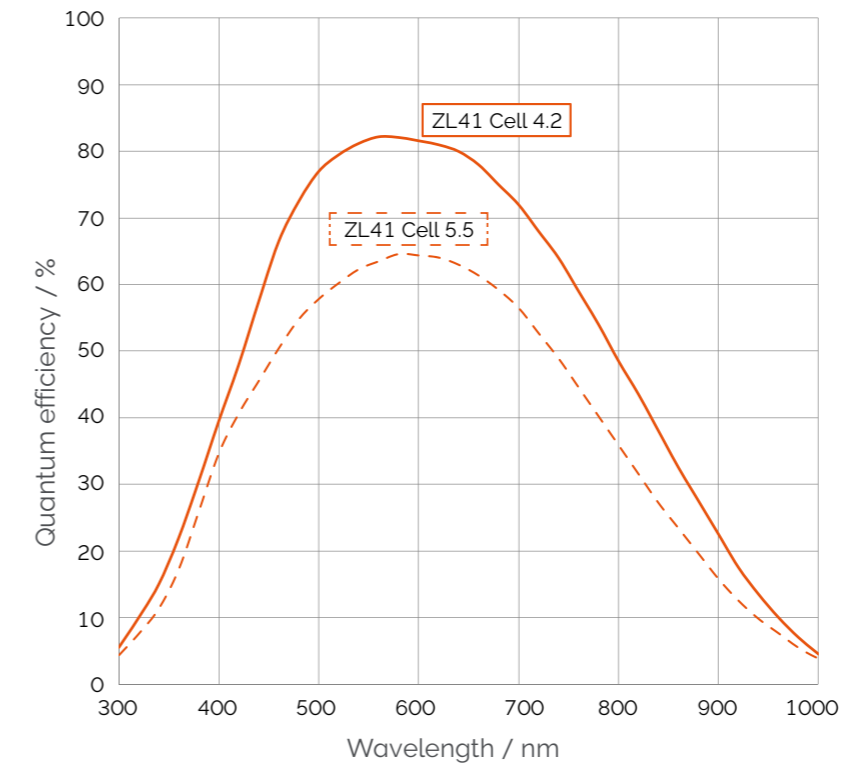

Frame Rate Table - 12-bit (16-Bit)^{*9}

Array Size	ZL41 Cell 5.5 USB 3.0		ZL41 Cell 5.5 Camera Link		ZL41 Cell 4.2 Camera Link	ZL41 Cell 4.2 USB 3.0
	Rolling Shutter	Global Shutter	Rolling Shutter	Global Shutter	Rolling Shutter	Rolling Shutter
2560 x 2160	40 (30)	40 (30)	100 (75)	49 (49)	-	-
2048 x 2048	53 (40)	52 (39)	105 (98)	52 (52)	101 (101)	53 (40)
1920 x 1080	107 (80)	98 (80)	200 (200)	97 (97)	192 (192)	107 (80)
512 x 512	422 (422)	201 (201)	422 (422)	201 (201)	406 (406)	406 (406)
128 x 128	1691 (1691)	716 (716)	1691 (1691)	716 (716)	1627 (1627)	1627 (1627)
2048 x 8 (FCS mode)	13020 (10250)	4008 (4008)	27057 (27057)	4008 (4008)	26041 (26041)	13020 (10250)
1024 x 8 (FCS mode)	27057 (27057)	4008 (4008)	27057 (27057)	4008 (4008)	26041 (26041)	26041 (26041)

Creating The Optimum Product for You

Step 1. Select the camera type



Camera Type

Description	Code
ZL41 Cell 4.2, 4.2 Megapixel, Rolling shutter, 100 fps, Camera Link, SRRF-Stream+ ready	ZYLA-4.2P-CL10-C
ZL41 Cell 4.2, 4.2 Megapixel, Rolling shutter, 53 fps, USB 3.0, SRRF-Stream+ ready	ZYLA-4.2P-USB3-C
ZL41 Cell 5.5, 5.5 Megapixel, Rolling and Global shutter, 40 fps, USB 3.0	ZYLA-5.5-USB3-C

For water cooled or spectroscopy options please enquire with your local sales representative.

Step 2. Select the required accessories

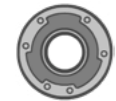

Accessories

Description	Order Code
SRRF-Stream+ real time super resolution for ZL41 Cell 4.2	SRRF-Stream-ZL-4P
CS-mount adapter	ACC-MEC-05609
F-mount adapter	ACM-05574
Auto extension tubes (set of 3) for C-mount	OA-ECMT
Auto extension tubes (set of 3) for Nikon F	OA-ENAF
Re-circulator for enhanced cooling performance	XW-RECR
Oasis 160 Ultra compact chiller unit	ACC-XW-CHIL-160
5 meter cable for use with Axion frame grabber for Camera Link models. (2 required)	ACC-ASE-13532
3 meter 7-way Multi I/O timing cable, offering Fire, External Trigger, Shutter and Arm.	ACC-ACZ-05612

Workstations are also available please enquire for more information. For further information on PC workstation requirements please refer to the technical note [PC Specifications for sCMOS Cameras](#)

Step 3. Select the required software



Software

ZL41 Cell also requires at least one of the following software options:

Solis Imaging A 32-bit and fully 64-bit enabled application for Windows (8.1, 10 and 11) offering rich functionality for data acquisition and processing. AndorBasic provides macro language control of data acquisition, processing, display and export.

Fusion Fully featured yet intuitive acquisition software. Integrated workflow to Imaris.

Andor SDK3 A software development kit that allows you to control the Andor range of cameras from your own application. Available as 32/64-bit libraries for Windows (8.1, 10 and 11) and Linux. Compatible with C/C++, C#, Delphi, VB.NET, LabVIEW, MATLAB and Python.

Third Party Software Drivers are available so that the ZL41 Cell can be operated through a wide range of third party imaging packages. ZL41 Cell maintains compatibility with the previous Zyla family. [See our third party software matrix for more information.](#)

Product Drawings

Dimensions in mm (inches)

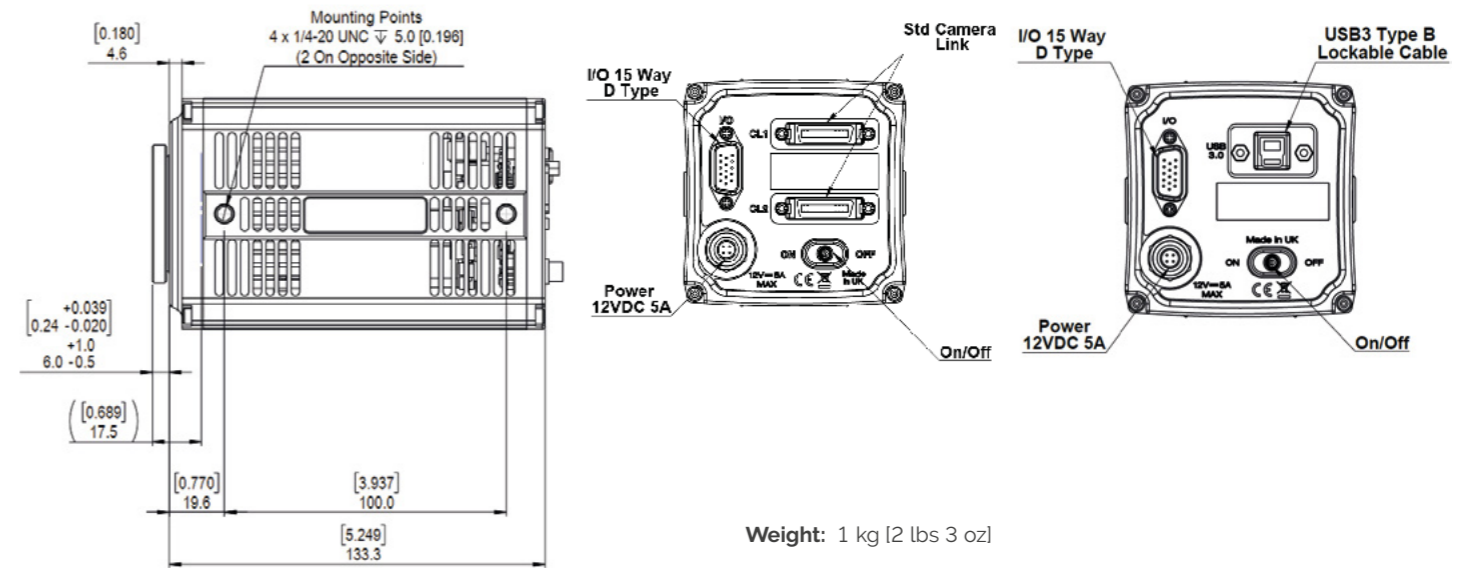
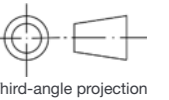

Weight: 1 kg (2 lbs 3 oz)

Product drawings of the water cooled ZL41 Cell can be found [here](#).

Regulatory Compliance

- RoHS compliant
- EU EMC Directive
- EU LV Directive
- IEC 61010-1 CB Scheme

External Power Supply Compliance

- UL-certified for Canada and US
- Japanese PSE Mark

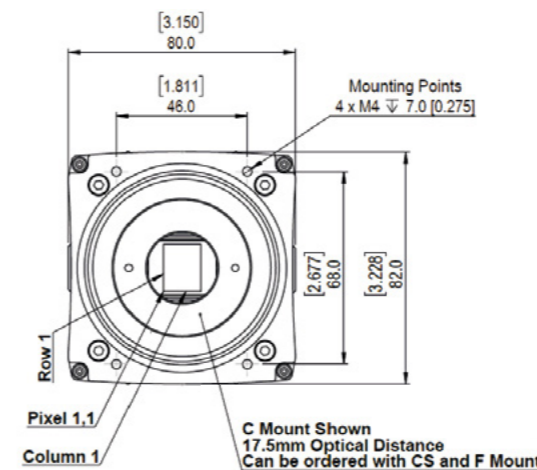

Connecting to the ZL41 Cell

Camera Control

Connector type: 3 meter Camera Link connectors or USB 3.0. (Longer lengths available as accessories).

TTL / Logic

1 x 3-way Multi I/O timing cable, offering Fire, External Trigger and Arm (1.5 meter)

Order Today

Need more information? At Andor we are committed to finding the correct solution for you. With a dedicated team of technical advisors, we are able to offer you one-to-one guidance and technical support on all Andor products.

For a full listing of our local sales offices, please see: andor.oxinst.com/contact

Our regional headquarters are:

Europe

Belfast, Northern Ireland
Phone +44 (28) 9023 7126
Fax +44 (28) 9031 0792

North America

Concord, MA, USA
Guangzhou
Phone +1 (860) 290 9211
Fax +1 (860) 290 9566

Japan

Tokyo
Phone +81 (3) 6744 4703
Fax +81 (3) 3446 8320

China

Beijing | Shanghai |
Phone +86 (400) 678 0609
Fax +86 (10) 5884 7901



Items shipped with your camera

For Camera Link Models: 1 x Camera Link Card and 2 x 3 meter connector cables.
For USB 3.0 models: 1 x USB 3.0 PCIe Card and 1 x 3 meter USB 3.0 cable (Type A to B)
1 x Power supply with mains cable)
1 x 3-way Multi I/O timing cable, offering Fire, External Trigger and Arm (1.5 meter)
1 x Quick Start Guide
1 x User guide in electronic format
1 x Individual system performance sheet

Minimum Computer Requirements:

2.68 GHz Quad Core
4GB RAM (increase RAM if to be used for continuous data spooling)
Hard Drive:
Minimum 450 MB/s continuous write for USB 3.0 models
Minimum 850 MB/s continuous write for Camera Link
PCI Express x4 or greater for USB 3.0 models
PCI Express x8 or greater for Camera Link
Windows (8.1, 10 or 11) or Linux
SRRF-Stream+
See andor.oxinst.com/products/srrf-stream

Operating and Storage Conditions

- Operating Temperature:
- ZL41 Cell 5.5: 0°C to 30°C ambient
- ZL41 Cell 4.2: 0°C to 27°C ambient
- Relative Humidity: < 70% (non-condensing)
- Storage Temperature: -10°C to 50°C

Footnotes: Specifications are subject to change without notice

1. Figures are typical unless otherwise stated.
2. Readout noise is for the entire system and is taken as a median over the sensor area excluding any regions of blemishes. It is a combination of sensor readout noise and A/D noise.
3. Quantum efficiency of the sensor at 20°C as supplied by the manufacturer.
4. Dark current measurement is taken as a median over the sensor area excluding any regions of blemishes.
5. Linearity is measured from a plot of Signal vs. Exposure Time, in accord with EMVA 1288 standard.
6. Software Exposure Events provide rapid software notification (SDK only) of the start and end of acquisition, useful for tight synchronization to moving peripheral devices e.g. Z-stage.
7. 'Global Clear' is an optional keep clean mechanism that can be implemented in rolling shutter mode, which purges charge from all rows of the sensor simultaneously, at the exposure start. The exposure end is still rolling shutter. It can be used alongside the Fire All output of the camera and a pulsed light source to simulate Global Exposure mechanism, albeit less efficiently than the true Global Shutter exposure mode of ZL41 Cell 5.5. Furthermore, Global Clear differs from true Global Shutter in that it can only be used in 'non-overlap' readout mode, i.e. sequential exposure and readout phases rather than simultaneous.
8. ZL41 Cell USB 3.0 models should work with any modern USB 3.0 enabled PC/laptop (provided hard drives or RAM is sufficient to support data rates) as every USB 3.0 port should have its own host controller. ZL41 Cell USB 3.0 models also ship with a USB 3.0 PCI card as a means to add a USB 3.0 port to an older PC, or as a diagnostic aid to interoperability issues or to ensure maximum speed.
9. The maximum frames/s table for ZL41 Cell indicate the maximum speed at which the device can acquire images in a standard system at full frame and also a range of sub-array size, for both rolling and global shutter read modes (ZL41 Cell 5.5), 12-bit single amplifier (rates also apply to dual amplifier 16-bit for ZL41 Cell 4.2). Sustained frame rates are dependent on write speed of the hard disc and other overheads of the acquisition software and hardware devices.

Power Requirements

- Power: +12 VDC ± 5% @ 5A
- Ripple: 200 mV peak-peak 0 - 20 MHz
- 100 - 240 VAC 50/60 Hz external power supply
- Power Consumption: 12 V @ 5 A Max, 12 V @ 2.5 A Nominal

