

Zyla sCMOS

Speed and Sensitivity for Physical Science Imaging and Spectroscopy

Key Specifications

- ✓ 4.2 or 5.5 megapixel sCMOS
- ✓ 12-bit and 16-bit modes
- ✓ 0.9 e⁻ read noise
- ✓ Up to 100 fps via Camera Link
- ✓ 33,000:1 dynamic range
- ✓ Rolling & True Global Shutter (Zyla 5.5)
- ✓ 82% peak QE (Zyla 4.2)

Key Applications

- ✓ Solar Astronomy
- ✓ Particle Imaging Velocimetry
- ✓ Lucky / Speckle Imaging
- ✓ Hyperspectral Imaging
- ✓ Adaptive Optics
- ✓ Bose Einstein Condensation
- ✓ Extensive Spectroscopy Modes



Features & Benefits

Andor's Zyla sCMOS camera platform offers high speed, high sensitivity and high resolution imaging and spectroscopy performance. The remarkably light and compact, thermoelectrically cooled design, integrates perfectly into both laboratory and OEM applications alike. Zyla is ideally suited to many cutting edge experiments that push the boundaries of speed and sensitivity.



Feature	Benefit
5.5 & 4.2 megapixel sensor formats and 6.5 μm pixels	Extremely sharp resolution over a 22 mm (Zyla 5.5) and 19 mm (Zyla 4.2 PLUS) diagonal field of view. Ideal for astronomy, area scanning applications or multi-track spectroscopy.
$\sim 1\text{e}^-$ Read Noise	Noise floor down to 0.9e^- . Lower detection limit than any CCD.
100 fps (Camera Link)	Zyla offers '10-tap' Camera Link for maximum sustained frame rates.
Up to 27,000 fps ('FCS' mode) or sps	Excellent time resolution capabilities for study of transient phenomena through user-definable Region of Interest control.
Rolling and Global shutter (Zyla 5.5)	Maximum exposure and readout flexibility across all applications. Global Shutter for freeze frame capture of fast moving/changing events.
12-bit and 16-bit modes	12-bit mode for fastest frame rates through USB 3.0; 16-bit mode for full dynamic range.
Market leading USB 3.0 speed	Superb USB 3.0 data transfer efficiency and Zyla's unique 12-bit high speed mode deliver up to 53 fps full resolution. Follow dynamic processes with improved temporal resolution.
Extended Dynamic Range	Unique 'dual gain amplifier' sensor architecture offering dynamic range of 33,000:1.
QE_{max} up to 82%	Highest available photon capture efficiency across visible/NIR.
ZERO etaloning in the NIR	Front-illuminated sensor architecture, no unwanted signal modulation in the NIR compared to back-illuminated devices.
Better than 99.8% linearity	Unparalleled quantitative measurement accuracy across the full dynamic range.
PIV mode inter-frame down to 100 ns	sCMOS sensor architecture allows rapid image pair acquisition with optical transition time between images down to 100 ns, well suited to a wide range of Particle Image Velocimetry (PIV) applications.
TE cooling to 0°C in up to 30°C ambient	Ideal for OEM integration into enclosed systems.
GPU Express	Simplify and optimize data transfers from camera to Graphical Processing Unit (GPU) card to facilitate accelerated GPU processing as part of the acquisition pipeline.
Hardware Timestamp	FPGA generated timestamp with 25 ns accuracy.
Compact and Light	Ideal for integration into space restrictive set-ups. Ideal for OEM.

NEW Spectroscopy Modes (option)

On-head asymmetric binning and multi-track	On-board intelligence delivering spectroscopists-friendly spectra and multi-track data prior to transfer through 10-tap or USB interface. Upfront data size reduction and easier user data processing.
Selectable bit-depth up to 32-bit	Preserve dynamic range in extensive on-head binning scenarios. User-selectable data bit depth to be transmitted over the camera interface, up to 32-bit.

Zyla - The Physicist's Choice

Zyla sCMOS has become a well established detector amongst physicists, biophysicists and astronomers, the advanced combination of speed, sensitivity and dynamic range enabling new ground to be broken.

- ✓ **Dual Amplifier** – novel pixel architecture means you don't need to pre-select gain. Access lowest read noise and full well depth simultaneously.
- ✓ **1000 fps** – Access extremely fast frame rates through user definable Region of Interest control, suited to many applications within the physical sciences.
- ✓ **GPU Express** – for real time processing.
- ✓ **Global Shutter** – Zyla 5.5 offers this important mode that completely avoids spatial distortion, and ensures temporal correlation across all regions of the sensor. Achieve sub-microsecond inter-frame gaps in PIV applications.
- ✓ **Low darkcurrent** – low read noise is complimented by extremely competitive darkcurrent, also ensuring minimized hot pixel blemishes.
- ✓ **Cooling options** – standard Zyla 5.5 camera air cools to 0°C at up to +30°C ambient. Water cooled option available on request.
- ✓ **Blemish correction maps and advanced control** Andor provide the capability to turn off/on blemish correction for those who prefer to perform this themselves. Bespoke blemish maps can also be provided.
- ✓ **Compact and Light** – the extremely small volume footprint of Zyla renders it adaptable to intricate optical set-ups.

Application Areas

Particle Imaging Velocimetry

The true Global Shutter mode of Zyla 5.5 facilitates an inter-frame gap of down to 100 ns.

Lucky / Speckle Imaging

Zyla's fast frame rate and large field of view are ideal for this resolution enhancing technique. GPU Express for real time data processing.

Solar Astronomy

Fast frame rates, wide dynamic range and great linearity present a very formidable solution to the specific detector needs of next generation large solar telescopes.

Bose Einstein Condensation

The QE profile of Zyla is very good in the red/NIR region, ideal for BEC of Rb.

Adaptive Optics

Accessing > 1000 fps using ROIs renders the Zyla an ideal Wavefront detector. Use with data splitter to enable direct data access.

Fluorescence Correlation Spectroscopy

Superb temporal resolution from small ROIs are excellent for accurately measuring diffusion coefficients.

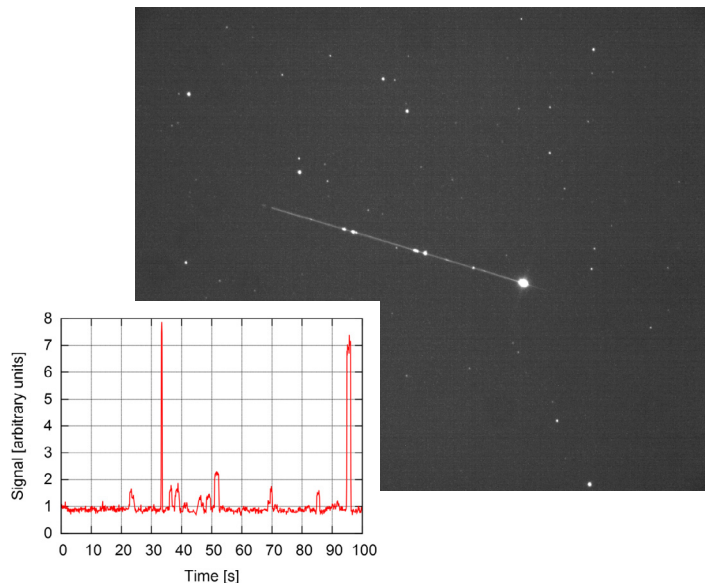

Zyla 5.5 operating at 10 Hz, detecting a Russian rocket upper stage - image and corresponding light curve shown. *Institute of Technical Physics Deutsches Zentrum für Luft- und Raumfahrt (DLR) - German Aerospace Center, Stuttgart, Germany.*

Spectroscopy Modes (option)

- ✓ **On-head asymmetric binning & multi-track**
Intelligent data processing from the sensor into Spectroscopy-friendly spectra or multi-channel data format, ahead of transfer through the 10-tap or USB interface; greatly reduces data post-processing and data set size at the user side.
- ✓ **User-definable bit depth**
Up to 32-bit data packaging option to overcome the limitation of the standard 16-bits data transfer through 10-tap or USB3 in extensive binning scenarios.

Hyperspectral Imaging & multi-track spectroscopy

On-head FPGA functions can discriminate up to 256 individual channels (e.g. multi-leg fibre optic) with no acquisition rate sacrifice compared to CCDs. Takes great advantage of Andor's spectrograph portfolio imaging portfolio.

Transient spectroscopy

Samples highly dynamic chemical reactions or phenomena with spectral rates up to 27,000 sps with 10-tap Zyla 5.5 and 26,000 sps with 10-tap Zyla 4.2.

Rolling & Global Shutter

The **Zyla 5.5** uniquely offers both Rolling and *true* Global Shutter exposure modes. This provides superior application and synchronization flexibility and the ability, through global exposure, to closely emulate the familiar 'Snapshot' exposure mechanism of interline CCDs.

Rolling & Global Shutter Mechanisms

Rolling and *true* Global Shutter modes describe two distinct types of exposure and readout sequence.

In rolling shutter, available in Zyla 4.2 PLUS and Zyla 5.5, different lines of the array are exposed at different times as the read out 'wave' sweeps through the sensor. 10 ms is required at the start to 'activate' the sensor to expose, and then 10 ms is required at the end to readout the sensor. Use when there is a minimal risk of spatial distortion from moving samples.

In true global shutter, available in Zyla 5.5, each pixel in the sensor begins the exposure simultaneously and ends the exposure simultaneously. This provides a true 'Snapshot' exposure capability for moving samples that is both 'photon-efficient' and easy to synchronize to. Zyla 4.2 PLUS, while utilizing a rolling shutter sensor, offers a *Simulated* Global Exposure mechanism to overcome risk of spatial distortion. This mechanism is more elaborate and less photon/time efficient than true Global Shutter. [Click here](#) to read more about Rolling and Global shutter modes on our Zyla camera.

Key Benefits of *True* Global Exposure

- ✓ **NO spatial distortion** – avoiding the spatial distortion risk of rolling exposure
- ✓ Tight syncing to **peripheral switching devices**
- ✓ **Higher signal to noise** due to reduced dead time – the entire exposure cycle can be used
- ✓ **Simplicity** – all the benefits of a 'snapshot exposure mode'
- ✓ **Continuous or pulsed** light sources
- ✓ 100 ns inter-frame gaps in PIV applications

Global Shutter exposure and readout (single scan)



Exposure Start

Exposure

Exposure End

Rolling Shutter exposure and readout (single scan)



Exposure Start

Exposure

Readout

'Simulated' Global Exposure in Zyla 4.2 PLUS

[Click here](#) to read more about this mode and other Frequently Asked Questions on Rolling and Global Exposure modes.

For further information of Rolling and Global Shutter, please access the following technical notes through the Andor Learning Centre: 1) Rolling and Global Shutter 2) Synchronizing to Rolling and Global Shutter sCMOS cameras

GPU Express



The Andor GPU Express library has been created to simplify and optimize data transfers from camera to a CUDA-enabled Nvidia Graphical Processing Unit (GPU) card to facilitate accelerated GPU processing as part of the acquisition pipeline. GPU Express integrates easily with SDK3 for Windows, providing a user-friendly but powerful solution for management of high bandwidth data flow challenges; ideal for data intensive applications such as tomography, 3D PIV or Adaptive Optics.

- ✓ Enhanced convenience, afforded by simple, optimized GPU data management
- ✓ Optimal data throughput
- ✓ Superb, easily accessible documentation and examples

Meet the Extended sCMOS Family for Physical Sciences

Marana sCMOS



Back-illuminated, deep cooled sCMOS
Ultimate sensitivity and large FoV

- ✓ Near earth object (NEO) detection
- ✓ Space debris tracking
- ✓ Solar astronomy
- ✓ Fast time resolution astrophysics
- ✓ Wafer inspection

[Read more](#)

Zyla sCMOS



For physical imaging, astronomy and spectroscopy

3D flow field study by PIV (using 4x Zyla), courtesy of Gioacchino Caferio, Universit' a di Napoli Federico II.

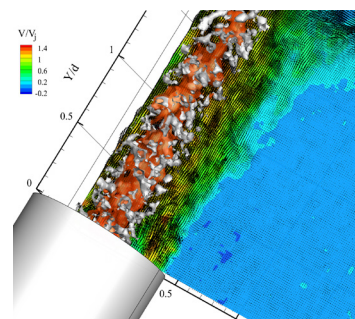

iStar sCMOS



For nanosecond gated imaging and spectroscopy

- ✓ Quantum physics
- ✓ Plasma diagnostics
- ✓ Flow/spray/combustion processes study
- ✓ Planar Laser-Induced Fluorescence (PLIF)
- ✓ Time-resolved luminescence

Plasma bullet time-dynamics studies, courtesy of Jérôme Bredin at York Plasma Institute.

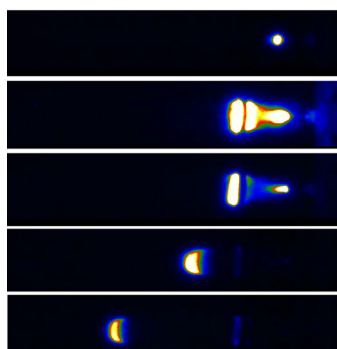

[Read more](#)

Zyla-HF



For indirect x-ray imaging

- ✓ Hard x-ray imaging and spectroscopy
- ✓ High Harmonic Generation (HHG)
- ✓ X-ray plasma spectroscopy
- ✓ X-ray tomography
- ✓ Transmission Electron Microscopy (TEM)

X-ray absorption image of a wasp taken with a 40 kV X-ray source, courtesy of Crytur.

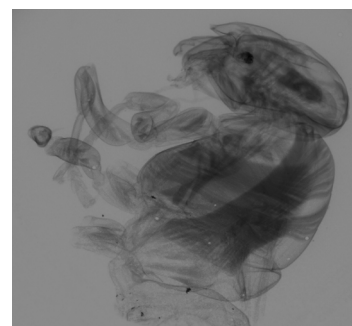

[Read more](#)

Balor sCMOS



Capture More. Further. Faster.

- ✓ Orbital debris & asteroid tracking
- ✓ Large sky surveys
- ✓ Solar studies
- ✓ Exoplanet discovery
- ✓ Supernovae detection

The highest resolution image of the Sun's surface ever taken using Balor sCMOS. Credit: NSO/AURA/NSF

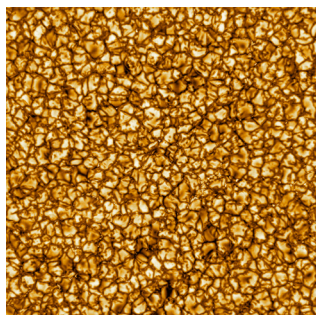

[Read more](#)

Balor-X sCMOS



Solution for High Energy Physics

- ✓ Hard x-ray & neutron tomography
- ✓ Hard x-ray microscopy
- ✓ X-ray diffraction & crystallography
- ✓ X-ray scattering - SAXS & WAXS
- ✓ Engineered material science

[Read more](#)

Technical Data

Model Specific Specifications^{*1}

Model	Zyla 5.5			Zyla 4.2 PLUS	
Sensor type	Front Illuminated Scientific CMOS			Front Illuminated Scientific CMOS	
Active pixels (W x H)	2560 x 2160 (5.5 Megapixel)			2048 x 2048 (4.2 Megapixel)	
Sensor size	16.6 x 14.0 mm 21.8 mm diagonal			13.3 x 13.3 mm 18.8 mm diagonal	
Pixel readout rate (MHz)	200 (100 MHz x 2 sensor halves) 560 (280 MHz x 2 sensor halves)			Slow Read 216 (108 MHz x 2 sensor halves) Fast Read 540 (270 MHz x 2 sensor halves)	
Read noise (e ⁻) Median [rms] ^{*2}	@ 200 MHz	Rolling Shutter 0.9 [1.2]	Global Shutter 2.3 [2.5]	@ 216 MHz	Rolling Shutter 0.90 [1.1]
	@ 560 MHz	1.2 [1.6]	2.4 [2.6]	@ 540 MHz	1.10 [1.3]
Maximum Quantum Efficiency ^{*3}	64%			82%	
Sensor Operating Temperature	0°C (up to 30°C ambient)			0°C (up to 27°C ambient)	
Air cooled					
Water cooled	-10°C*			-10°C*	
Dark current, e ⁻ /pixel/sec @ min temp ^{*4}	0.10			0.10	
Air cooled	0.019			0.019	
Water cooled					
Readout modes	Rolling Shutter and True Global Shutter (Snapshot)			Rolling Shutter and Global Clear ^{*8}	
Maximum dynamic range	33,000:1			33,000:1	
Photon Response Non-Uniformity (PRNU)					
Half-light range	< 0.01%				
Low light range	< 0.1%				
Pre-defined Region of Interest (ROI)	2048 x 2048, 1920 x 1080, 1392 x 1040, 512 x 512, 128 x 128			1920 x 1080, 1392 x 1040, 512 x 512, 128 x 128	
User defined ROI (granularity)	Yes (1 pixel) ^{**}				
Data range	12-bit (fastest USB 3.0 speeds) and 16-bit (maximum dynamic range)				
Interface options	USB 3.0 ^{*9} Camera Link 10-tap				

* Cooling temperature must be above the dew point

** Minimum ROI size: 4 x 8 (W x H) possible for 12- or 16-bit modes and for both Camera Link 10-tap and USB 3.0 models

General Specifications^{*1}

Pixel size (W x H)	6.5 µm
Pixel well depth (e ⁻)	30,000
Linearity (% maximum) ^{*5}	
Full light range	Better than 99.8%
Low light range (< 1000 electrons signal)	Better than 99.9%
MTF (Nyquist @ 555 nm)	45%
Pixel binning	Hardware binning: 2 x 2, 3 x 3, 4 x 4, 8 x 8
Anti-blooming factor	x 10,000
I/O	External Trigger, Fire, Fire n, Fire All, Fire Any, Arm
Trigger Modes	Internal, External, External Start, External Exposure, Software Trigger
Software Exposure Events ^{*6}	Start exposure - End exposure (row 1), Start exposure - End exposure (row n)
Hardware timestamp accuracy	25 ns
Internal memory	1 GB



Imaging Mode

Frame Rate Table - 12-bit (16-bit)*⁷

Array Size (W x H)	Zyla 5.5 USB 3.0		Zyla 5.5 10-tap		Zyla 4.2 PLUS 10-tap	Zyla 4.2 PLUS USB 3.0
	Rolling Shutter	Global Shutter	Rolling Shutter	Global Shutter	Rolling Shutter	Rolling Shutter
2560 x 2160	40 (30)	40 (30)	100 (75)	49 (49)	-	-
2048 x 2048	53 (40)	52 (39)	105 (98)	52 (52)	101 (101)	53 (40)
1920 x 1080	107 (80)	98 (80)	200 (200)	97 (97)	192 (192)	107 (80)
512 x 512	422 (422)	201 (201)	422 (422)	201 (201)	406 (406)	406 (406)
128 x 128	1691 (1691)	716 (716)	1691 (1691)	716 (716)	1627 (1627)	1627 (1627)
2048 x 8 (FCS mode)	13020 (10250)	4008 (4008)	27057 (27057)	4008 (4008)	26041 (26041)	13020 (10250)
1024 x 8 (FCS mode)	27057 (27057)	4008 (4008)	27057 (27057)	4008 (4008)	26041 (26041)	26041 (26041)



Spectroscopy Mode

Vertically binned tracks 12 & 16-bit*⁷

Array Size (W x H)	Zyla 5.5 10 tap / USB 3.0		Zyla 4.2 PLUS 10 tap/USB 3.0
	Rolling Shutter*	Global Shutter**	Rolling Shutter*
any x 8	27,057	4,008	26,041
any x 12	18,038	3,491	17,361
any x 16	13,528	3,092	13,020
any x 31	6,764	2,122	6,510
any x 77	2,705	1,093	2,604
any x 100	2,164	909	2,083
any x 128	1,691	736	1,627
any x 154	1,387	618	1,335
any x 462	466	224	448
any x 512	422	203	406
any x 1040	208	102	200
any x 1080	200	98	192
any x 2048	105	52	101



Multi-track Mode

Vertically binned tracks 12 & 16-bit*⁷

Number of tracks (centred vertically)	Track height (h, pixels)	Tracks separation (d, pixels)	Zyla 5.5 10-tap / USB 3.0		Zyla 4.2 PLUS 10-tap/USB 3.0
			Rolling Shutter*	Global Shutter**	Rolling Shutter*
2	12	12	6,012	1,967	5,787
2	20	20	3,607	1,370	3,472
2	154	77	557	265	536
20	12	12	462	222	445
20	20	20	277	135	267
50	12	12	182	89	175
50	20	20	109	54	105
256	8	0	105	52	101

* Overlap ON
** Overlap OFF

How the sCMOS sensor is used in the different modes

The diagrams below illustrate how the sCMOS sensor array is used for the different modes (in this example for the Zyla 4.2 PLUS).

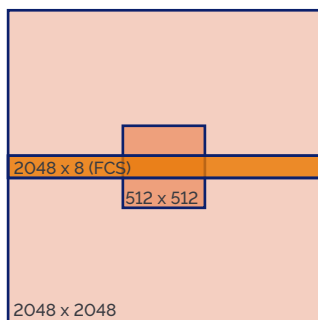

I Imaging Mode
The array size may be defined (includes FCS modes) for either resolution or maximum speed.

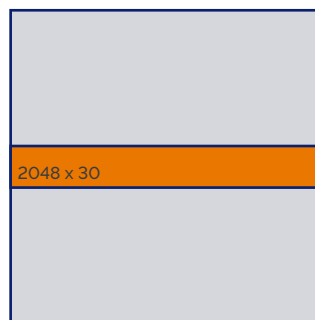

S Spectroscopy Mode
A vertically binned track is centred on the sensor enabling the maximum spectral rate to capture dynamic events.

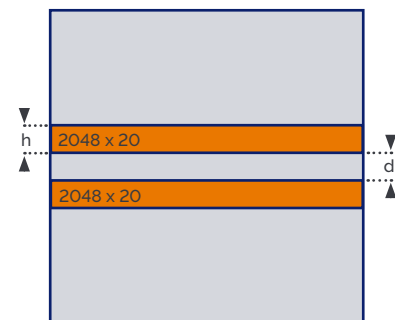

M Multi-track Mode
Up to 256 vertically binned tracks can be used for multi-track analysis without sacrificing speed.

Quantum Efficiency (QE) Curve ³

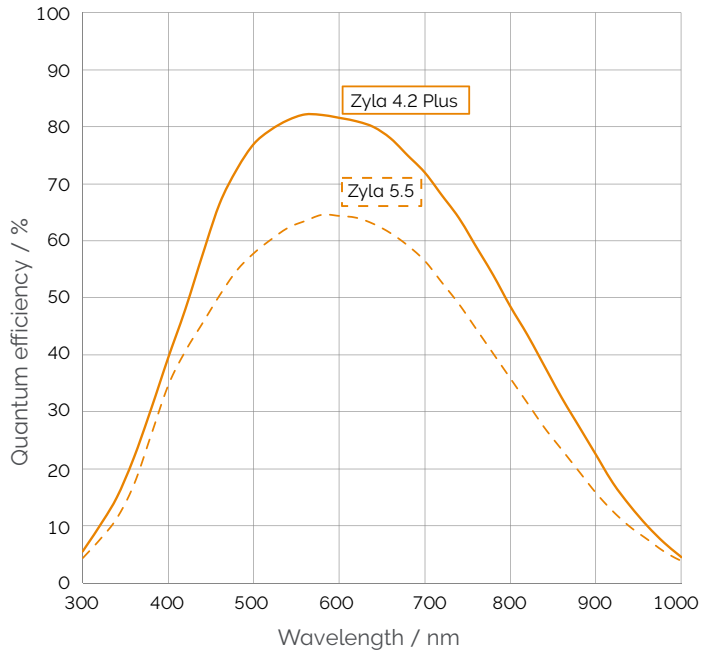

sCMOS for Spectroscopy and Andor Research-grade Spectrographs

Highly modular motorized platforms with dual output ports, dual/triple/quadruple grating turrets and a wide range of motorized and field-upgradable accessories.

Shamrock 750
Delivers the highest spectral resolution of the spectrograph range, down to 0.02 nm.

Shamrock 163
Rugged, compact 163 mm focal length manual spectrograph, highly configurable for general, everyday lab spectroscopy.

Kymera 193i
Intelligent, modular and compact imaging spectrograph with Adaptive Focus technology, fully motorized, RFID-tagged dual grating turret, dual detector output ports and seamless interfacing to microscopes for micro-spectroscopy applications.

Shamrock 500i
Ideal combination of high spectral resolution, imaging capabilities for multi-track acquisitions. Convenient USB interface alongside fully motorized platform and light coupling accessories.

Kymera 328i
Intelligent, modular and compact imaging spectrograph with Adaptive Focus technology and intelligent TruRes™ spectral resolution enhancement option. Quad grating turret and dual input and output ports allow ease of integration into demanding optical setups or multi-modal laboratories.

Resolution Calculator
andor.com/calculators 

sCMOS or EMCCD?

Since the introduction of sCMOS technology by Andor, the question of the performance comparison against the more established Electron Multiplying CCD (EMCCD) has been common.

sCMOS offer a very fast, low noise technology, which holds potential as an alternative to single photon sensitive detectors across some applications and techniques, including cold atom imaging or fast spectral chemical mapping.

Whilst the read noise of sCMOS is very low compared to CCDs, EMCCD technology holds the distinct advantage of being able to practically eliminate read noise, rendering them single photon sensitive.

A decade on from the release of the first sCMOS detectors, there are still applications that benefit from the ultra-sensitive EMCCD technology.

For example quantum optics, photon counting and some astronomy applications such as Lucky Astronomy and wave front detection.

EMCCDs offer a raw sensitivity that cannot be surpassed in the very low light regime. However, EMCCDs remain relatively expensive, so they will always be considered a more selective, 'high-end' solution.

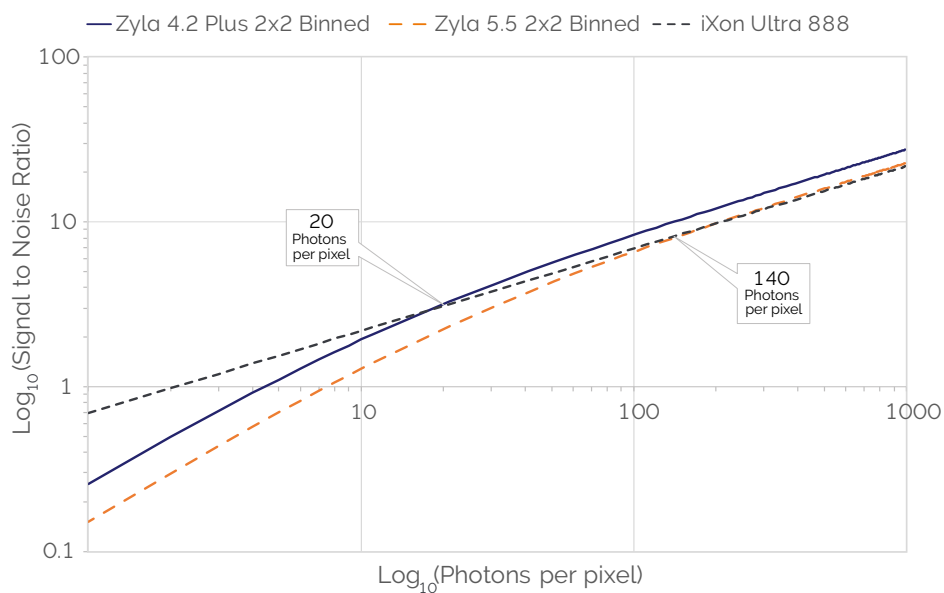

Plot of Signal to Noise Ratio versus Incident Photon Intensity, comparing back-illuminated EMCCD iXon 888 (13 μm pixel size) to 2x2 binned Zyla sCMOS cameras (13 μm pixel size after binning). Calculations were performed using our online [signal to noise calculator tool available here](#).

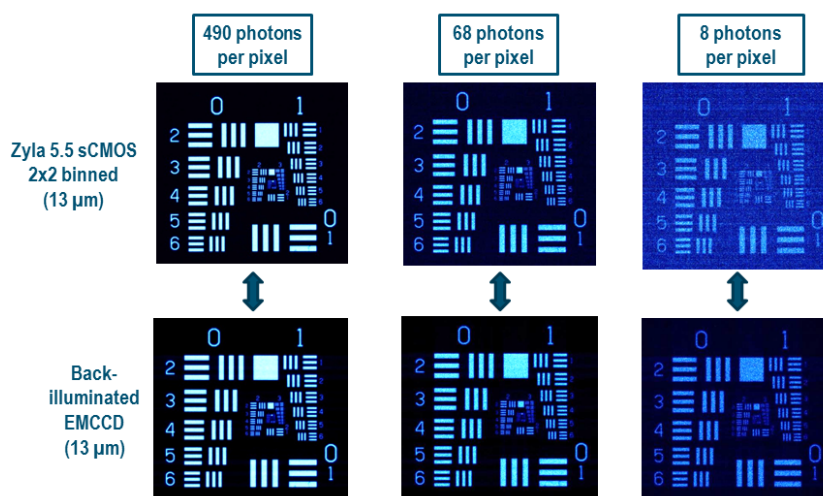

Images at a range of incident light intensity, acquired using back-illuminated EMCCD iXon 888 and Zyla 5.5 sCMOS cameras (2x2 binned pixels). At low light intensities, the Signal to Noise Ratio advantage of the EMCCD is apparent.

Step 1. Select the camera type

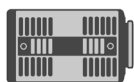

Camera Type

Description	Code
ZYLA 4.2 PLUS, 4.2 Megapixel, Rolling shutter, Camera Link 10-tap	ZYLA-4.2P-CL10
ZYLA 4.2 PLUS, 4.2 Megapixel, Rolling shutter, USB 3.0	ZYLA-4.2P-USB3
ZYLA 5.5, 5.5 Megapixel, Rolling and Global shutter, Camera Link 10-tap	ZYLA-5.5-CL10
ZYLA 5.5, 5.5 Megapixel, Rolling and Global shutter, USB 3.0	ZYLA-5.5-USB3

For Spectroscopy mode option, add -S to your selected camera codes
For water cooled option, add -W to your selected camera code

Step 2. Select the required accessories

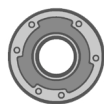

Accessories

Description	Order Code
F-mount adapter	ACM-05574
Auto extension tubes (set of 3) for C-mount	OA-ECMT
Auto extension tubes (set of 3) for Nikon F	OA-ENAF
Re-circulator for enhanced cooling performance	XW-RECR
Oasis 160 Ultra compact chiller unit	ACC-XW-CHIL-160
3 meter 7-way Multi I/O timing cable, offering Fire, External Trigger, Shutter and Arm.	ACC-ACZ-05612
5 meter cable for use with Axion frame grabber for Camera Link 10-tap models. (2 cables required)	ACC-ASE-13532
30 meter fibre-optic extender solution for Camera Link 10-tap models.	ACC-ZYLFOX-10TAP-30M
100 meter fibre-optic extender solution for Camera Link 10-tap models.	ACC-ZYLFOX-10TAP-100
15 meter active USB 3.0 connector cable (power supply not required). For use with Zyla USB 3.0 models.	ACC-ASE-06887
50 meter fibre optic USB 3.0 extender solution including power supply. For use with Zyla USB 3.0 models.	ACC-ASE-08762
100 meter fibre optic USB 3.0 extender solution including power supply. For use with Zyla USB 3.0 models.	ACC-ASE-07860
PC Workstation for up to 100 fps continuous spooling to hard drives, acquiring up to 120,000 12-bit full resolution images: Dell T7910XL, 2.6 GHz Eight Core, 8 GB RAM, 4 x 250GB SSD hard drive configured in RAID 0.	WKST-1 WIN
PC Workstation for up to 100 fps continuous spooling to RAM, acquiring up to 6,000 12-bit full resolution images: Dell T5810, 3.5 GHz Quad Core, 64 GB RAM.	WKST-3 WIN

For further information on PC workstations for Zyla, please refer to the technical note [PC Specifications for sCMOS](#)

Step 3. Select the required software



Software

The Zyla also requires at least one of the following software options:

Solis Spectroscopy A 32-bit and fully 64-bit enabled application for Windows (8, 8.1 and 10) offering rich functionality for data acquisition and processing. AndorBasic provides macro language control of data acquisition, processing, display and export.

Andor SDK3 A software development kit that allows you to control Andor sCMOS cameras from your own application. Available as a 32 or 64-bit library for Windows (8, 8.1 and 10) and Linux. Compatible with C/C++, LabView and Matlab.

GPU Express Andor GPU Express library has been created to simplify and optimize data transfers from camera to a CUDA-enabled Nvidia Graphical Processing Unit (GPU) card to facilitate accelerated GPU processing as part of the acquisition pipeline. Integrates easily with Andor SDK3 for Windows.

Third party software compatibility

Drivers are available so that the Zyla can be operated through a large variety of third party software packages. See [Andor website for detail](#).

Product Drawings

Dimensions in mm [inches]

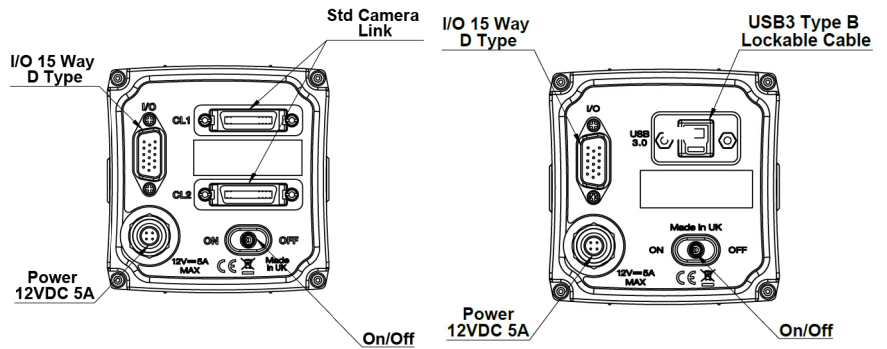
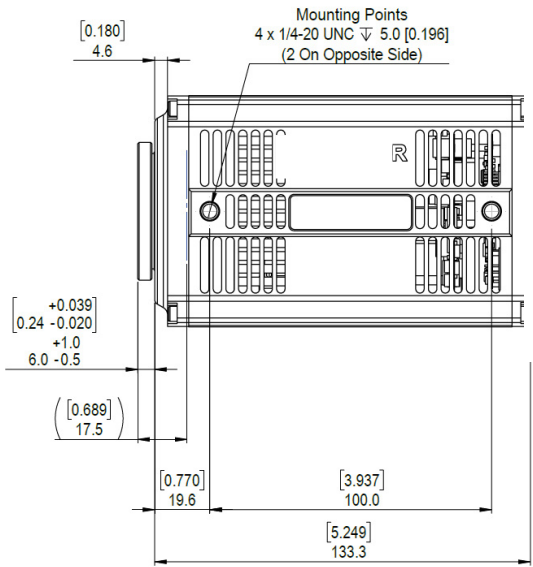
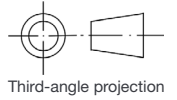

Weight: 1,000 g [2 lbs 3 oz]

Product drawings of the water cooled Zyla can be found [here](#).

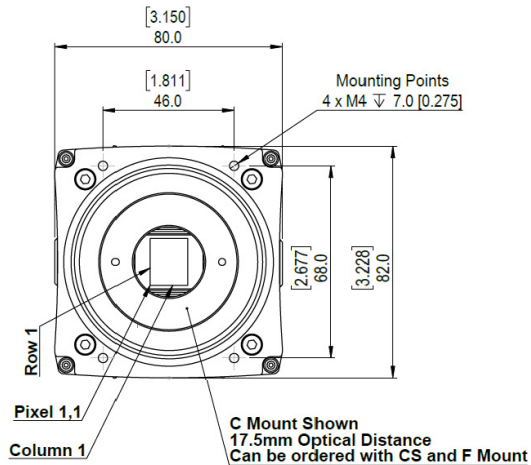

Connecting to the Zyla

Camera Control

Connector type: 3 meter Camera Link 10-tap connectors or USB 3.0. (Longer lengths available as accessories).

TTL / Logic

1 x 3-way Multi I/O timing cable, offering Fire, External Trigger and Arm (1.5 meter)

Regulatory Compliance

- RoHS compliant
- EU EMC Directive
- EU LV Directive
- IEC 61010-1 CB Scheme

External Power Supply Compliance

- UL-certified for Canada and US
- Japanese PSE Mark

POWER SUPPLY REQUIREMENTS

- Power: +12 VDC \pm 5% @ 5A
- Ripple: 200 mV peak-peak 0 - 20 MHz
- 100 - 240 VAC 50/60 Hz external power supply
- Power Consumption: 12V @ 5A Max, 12V @ 2.5A Nominal

15-way D-type pinouts

1	ARM	Output
2	Aux_Out_1*	Output
3	FIRE row n	Output
4	FIRE row 1	Output
5	Aux_Out_2	Output
6	Ground	GND
7	External Trigger	Input
8	Spare Input	Input
9	Reserved	N/A
10	Reserved	N/A
11	Reserved	N/A
12	Reserved	N/A
13	Reserved	N/A
14	Reserved	N/A
15	Reserved	N/A

* Aux_Out_1 is configurable as Fire, Fire n, Fire All or Fire Any. Refer to the Zyla hardware manual.

Order Today

Need more information? At Andor we are committed to finding the correct solution for you. With a dedicated team of technical advisors, we are able to offer you one-to-one guidance and technical support on all Andor products.

For a full listing of our local sales offices, please see: andor.com/contact

Our regional headquarters are:

Europe

Belfast, Northern Ireland
Phone +44 (28) 9023 7126
Fax +44 (28) 9031 0792

Japan

Tokyo
Phone +81 (3) 6732 8968
Fax +81 (3) 6732 8939

North America

Concord, MA, USA
Phone +1 (860) 290 9211
Fax +1 (860) 290 9566

China

Beijing
Phone +86 (10) 5884 7900
Fax +86 (10) 5884 7901

Items shipped with your camera

For Camera Link 10-Tap Models: 1 x Camera Link Card and 2 x 3 meter connector cables.
For USB 3.0 models: 1 x USB 3.0 PCIe Card and 1 x 3 meter USB 3.0 cable (Type A to B)
1 x Power supply with mains cable
1 x 3-way Multi I/O timing cable, offering Fire, External Trigger and Arm (1.5 meter)
1 x Quick Start Guide
1 x Electronic copy of user guide
1 x Individual system performance sheet

Minimum Computer Requirements:

- 2.68 GHz Quad Core
- 4GB RAM (increase RAM if to be used for continuous data spooling)

Hard Drive:

- Minimum 450 MB/s continuous write for USB 3.0 models
- Minimum 850 MB/s continuous write for Camera Link 10-tap models
- PCI Express x4 or greater for USB 3.0 models
- PCI Express x8 or greater for Camera Link 10-tap models
- Windows (8, 8.1 or 10) or Linux

*See technical note entitled: 'PC Specifications for sCMOS'

** Note, Andor supply PC workstations for Zyla, see page 10.

Operating and Storage Conditions

Operating Temperature:

- Zyla 5.5: 0°C to 30°C ambient
- Zyla 4.2: 0°C to 27°C ambient
- Relative Humidity: < 70% (non-condensing)
- Storage Temperature: -10°C to 50°C

Power Requirements

- Please refer to page 11

Footnotes:

Specifications are subject to change without notice

1. Figures are typical unless otherwise stated.
2. Readout noise is for the entire system and is taken as a median over the sensor area excluding any regions of blemishes. It is a combination of sensor readout noise and A/D noise.
3. Quantum efficiency of the sensor at 20°C.
4. Dark current measurement is taken as a median over the sensor area excluding any regions of blemishes.
5. Linearity is measured from a plot of Signal vs. Exposure Time over the full dynamic range.
6. Software Exposure Events provide rapid software notification (SDK only) of the start and end of acquisition, useful for tight synchronization to moving peripheral devices e.g. Z-stage.
7. The maximum frames/s table for Zyla indicate the maximum speed at which the device can acquire images in a standard system at full frame and also a range of sub-array size, for both rolling and global shutter read modes (Zyla 5.5), 12-bit single amplifier (rates also apply to dual amplifier 16-bit for Zyla 4.2). Note that the write speed of the PC hard drive can impose a further restriction to achieving sustained kinetic series acquisition.
8. 'Global Clear' is an optional keep clean mechanism that can be implemented in rolling shutter mode, which purges charge from all rows of the sensor simultaneously, at the exposure start. The exposure end is still rolling shutter. It can be used alongside the Fire All output of the camera and a pulsed light source to simulate Global Exposure mechanism, albeit less efficiently than the true Global Shutter exposure mode of Zyla 5.5. Furthermore Global Clear differs from true Global Shutter in that it can only be used in 'non-overlap' readout mode, i.e. sequential exposure and readout phases rather than simultaneous.
9. Zyla USB 3.0 models should work with any modern USB 3.0 enabled PC/laptop (provided hard drives or RAM is sufficient to support data rates) as every USB 3.0 port should have its own host controller. Zyla USB 3.0 models also ship with a USB 3.0 PCIe card as a means to add a USB 3.0 port to an older PC, or as a diagnostic aid to interoperability issues or to ensure maximum speed.

